

MULTI-STAGE VACUUM GENERATORS PVP 12 MX and 25 MX

This new range of multiple ejector vacuum generators represents the natural evolution of the PVP 12M and 25M generators. In fact, given the same air consumption and final vacuum level, the maximum suction capacity is increased from 15 to 21 cum/h and from 25 to 31 cum/h respectively.

The body and the lid are made with anodised aluminium, all the ejectors are made with stainless steel, as well as the fixing screws.

The state of the art seal in EPDM and is never in contact with the sucked fluid. The reed valves, on the other hand, are made with silicon as a standard, and viton, upon request. The devices are also equipped with two new vacuum connections, apart from the existing one, and one for the possible connection to control or measuring devices.

As a standard, the devices are equipped with a vacuum gauge, a quick coupler for compressed air supply and metal locking caps for the unused connections.

The exhaust air connections are threaded in order to allow the installation of the new SSX silencers, for a further noise reduction.

They are perfectly interchangeable with the previous generators.

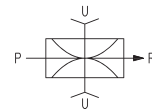
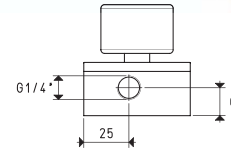
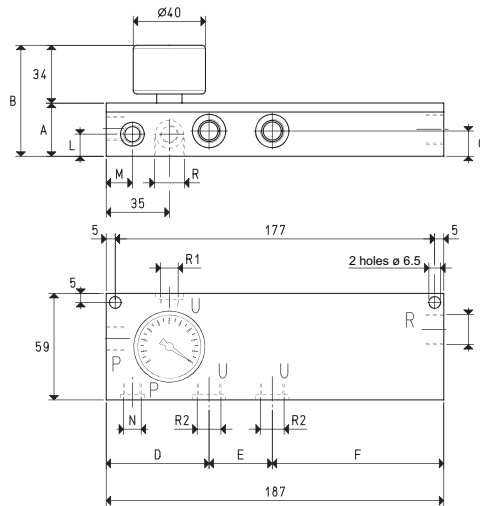

P=COMPRESSED AIR CONNECTION R=EXHAUST U=VACUUM CONNECTION

Art.		PVP 12 MX				PVP 25 MX	
Max. quantity of sucked air	cum/h	16.0	18.0	21.0	25.0	28.0	31.0
Max. vacuum level	-KPa	65	85	90	65	85	90
Final pressure	mbar abs.	350	150	100	350	150	100
Supply pressure	bar (g)	4	5	6	4	5	6
Air consumption	NI/s	1.3	1.5	1.8	2.3	2.7	3.2
Working temperature	°C	-20 / +80				-20 / +80	
Noise level	dB(A)	65				70	
Weight	g	660				960	
A		29.5				45.5	
B		63.5				79.5	
C		15.5				20.7	
D		57.0				60.5	
E		35.0				37.0	
F		95.0				89.5	
G		14.0				20.7	
L		--				20.75	
M		--				14.5	
N		--				G1/8"	
I	Exhaust connection	∅		G3/8"		N° 4 x G1/4"	
R	Vacuum connection	∅		G3/8"		G3/8"	
R 1	Auxiliary vacuum connection	∅		G1/8"		G1/8"	
R 2	Additional vacuum connection	∅		G1/4"		G1/2"	
Spare parts							
Sealing kit and reed valve	art.	00 KIT PVP 12 MX				00 KIT PVP 25 MX	
Vacuum gauge	art.	09 03 15				09 03 15	

Note: All the vacuum data indicated in the table are valid at the normal atmospheric pressure of 1013 mbar and are obtained with a constant supply pressure.

8.66

Conversion ratio: inch = $\frac{\text{mm}}{25.4}$, pounds = $\frac{\text{g}}{453.6}$ = $\frac{\text{Kg}}{0.4536}$

GAS-NPT thread adapters available at page 1.117



8



MULTI-STAGE VACUUM GENERATORS PVP 12 MX and 25 MX

Air capacity (NI/s) at different vacuum levels (-Kpa)

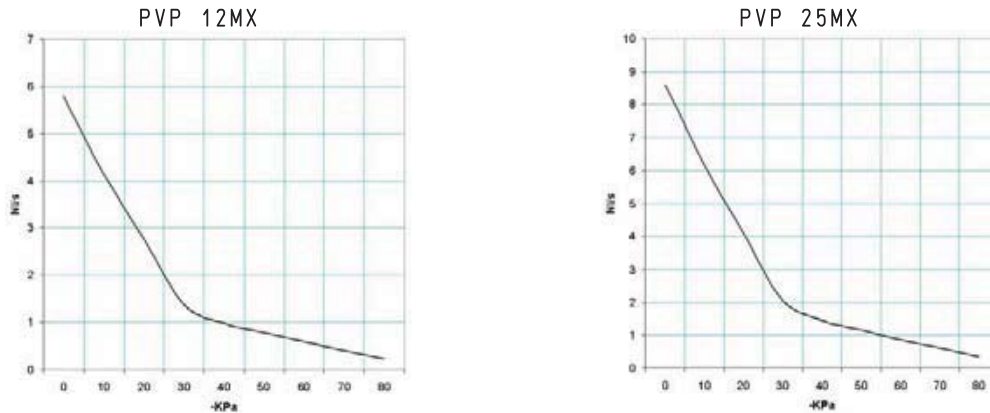

Generator art.	Supply press. bar (g)	Air consumption NI/s	Air capacity (NI/s) at different vacuum levels (-KPa)										Max. vacuum level -KPa
			0	10	20	30	40	50	60	70	80	90	
PVP 12 MX	6.0	1.8	5.80	4.14	2.76	1.38	0.98	0.78	0.59	0.41	0.23	90	
PVP 25 MX	6.0	3.2	8.61	6.15	4.10	2.05	1.46	1.17	0.88	0.61	0.35	90	

Evacuation time (ms/l=s/m³) at different vacuum levels (-Kpa)

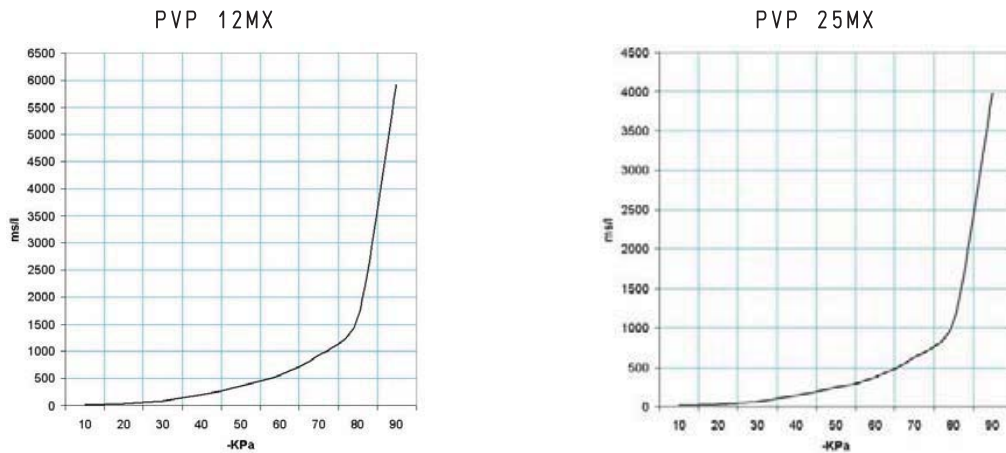

Generator art.	Supply press. bar (g)	Air consumption NI/s	Evacuation time (ms/l = s/m³) at different vacuum levels (-KPa)										Max. vacuum level -KPa
			10	20	30	40	50	60	70	80	85	90	
PVP 12 MX	6.0	1.8	15.4	38.7	85.1	204.4	365.9	559.8	929.4	1607.8	5916	90	
PVP 25 MX	6.0	3.2	10.4	26.0	57.3	137.7	246.5	377.1	626.0	1083.1	3986	90	

Accessories upon request

Silencer art. SSX 3/8" for PVP 12MX

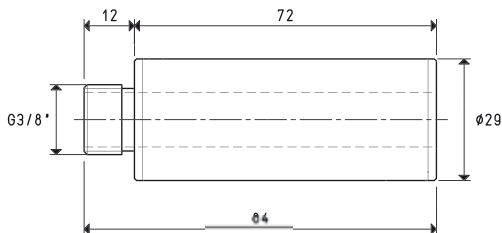

4 silencers art. SSX 1/4 for PVP 25 MX

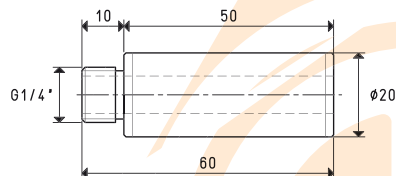

Conversion ratio: inch = $\frac{mm}{25.4}$ · pounds = $\frac{g}{453.6}$ = $\frac{Kg}{0.4536}$

GAS-NPT thread adapters available at page 1.117

8.67

